

# DE1177 SEPARATOR DUNNAGE

## 1.50" INDEX

## .32" POCKET

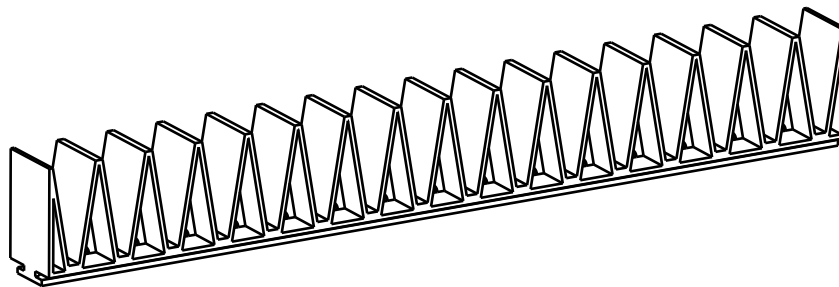
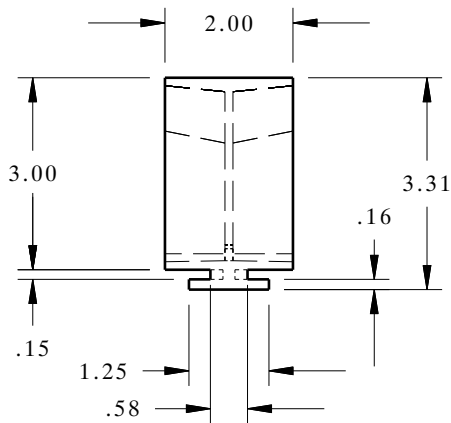
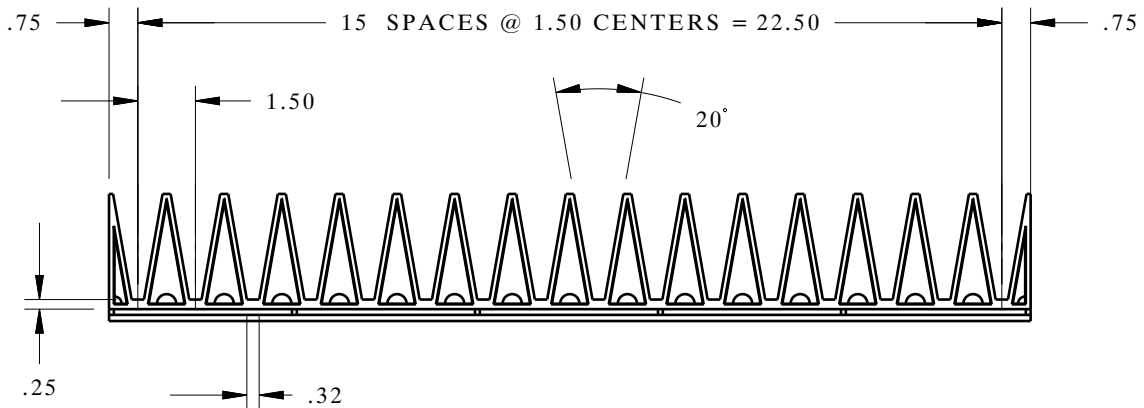

**MATERIAL TYPE**  
PC / PBT

**HARDNESS**

**COLOR**  
Black

**1.50" INDEX, .32" POCKET**

**Applications:**

**-Part Separation**

 **Dunnage  
Engineering**

800-443-5553

www.dunnage-eng.com